

NOVA LUCE

9260212

1

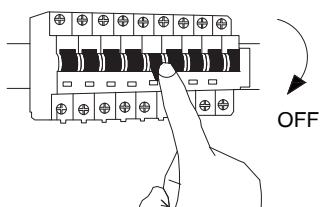

Turn off the general switch

2

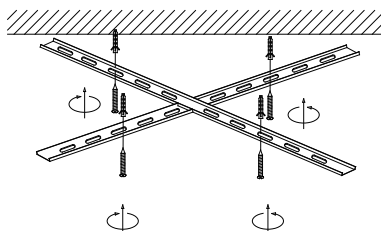

Align, mark and drill holes to apply the screws

3

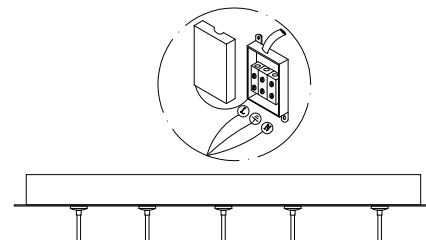

Connect the 3 wires

4

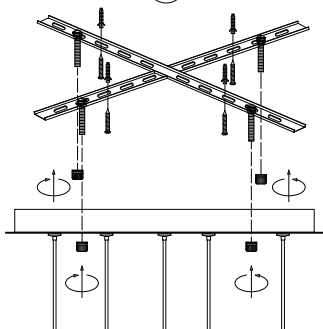

Apply the side screws

5

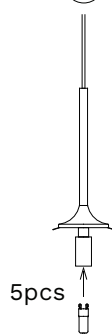

Insert the light bulb

6

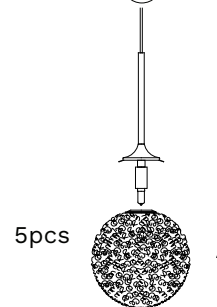

Fix the cap by tidying it up

7

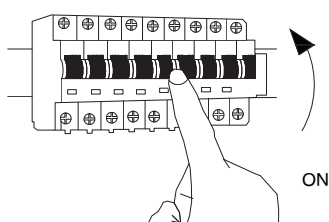

Turn on the general switch

