

1

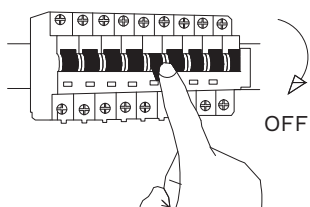

Turn off the general switch

2

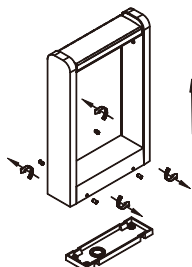

Untie the screws

3

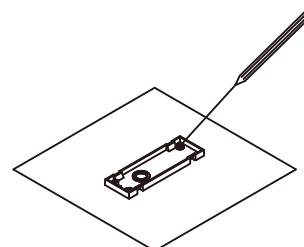

Mark the areas

4

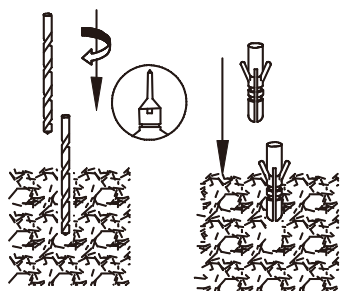

Drill holes & apply plastic anchors

5

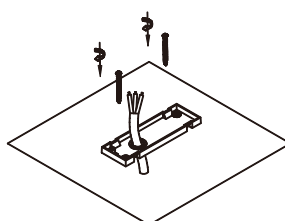

Tie up the screws to make it stable

6

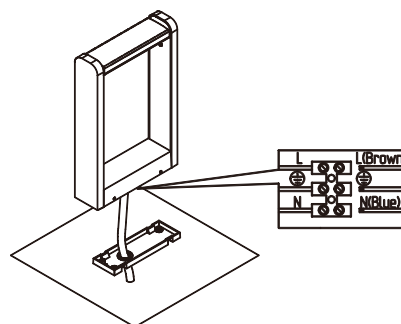

Connect the wires

7

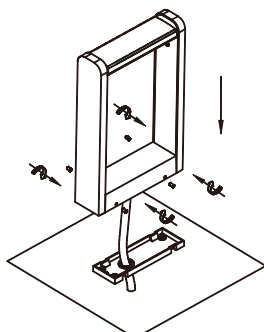

Tie up the side screws

8

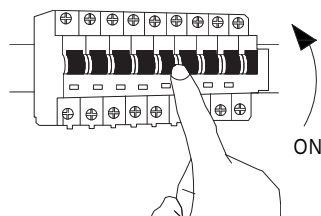

Turn on the general switch

