

# NOVA LUCE

9006053

1

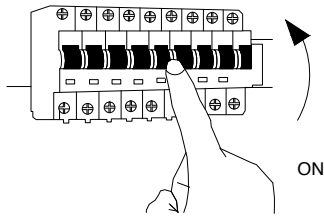

Turn off the general switch

2

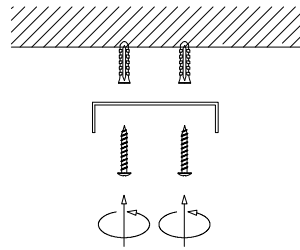

Align, mark & drill holes,  
Apply plastic anchors & tie up screws

3

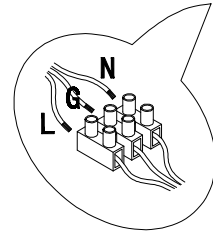

Connect wires

4

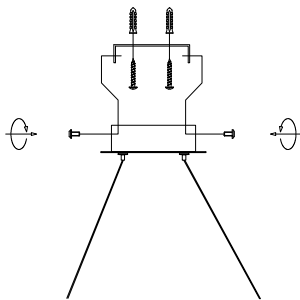

Tie up side screws  
to put it in place

5

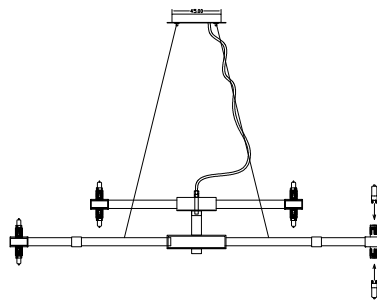

Insert the bulbs

6

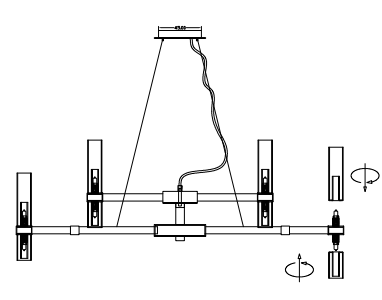

Tie up the caps by rotate

7

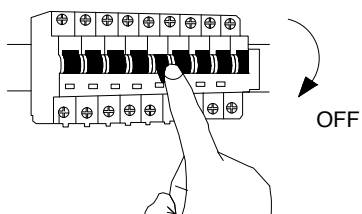

Turn on the general Switch

