

1

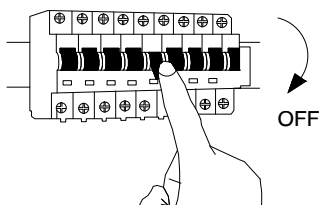

Turn off the general switch

2

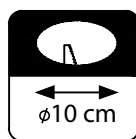
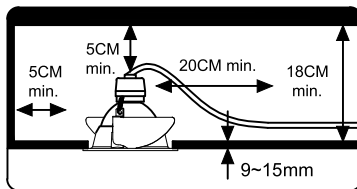

Create CutOut

3

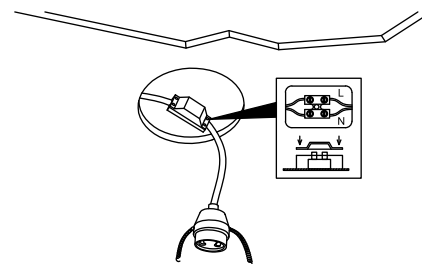

Connect wires

4

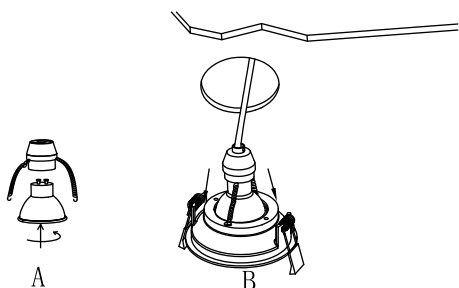

Insert the bulb by rotate  
Press the brackets upwards

5

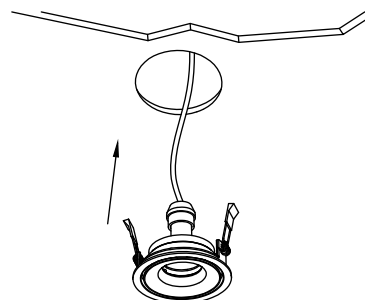

Place the luminaire into the hole

6

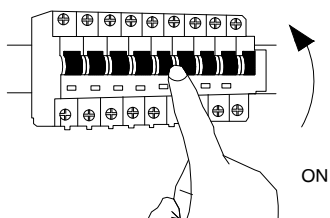

Turn on the general switch

7

