

NOVA LUCE

711024

1

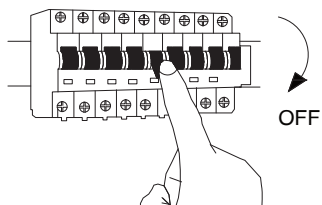

Turn off the general switch

2

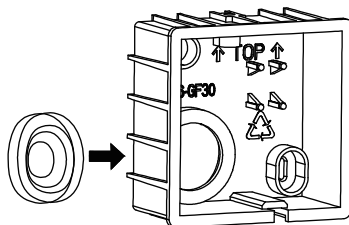

Adjust elastic part

3

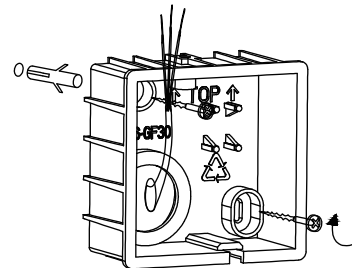

Drill holes apply plastic anchors
Tie up screws to make it stable

4

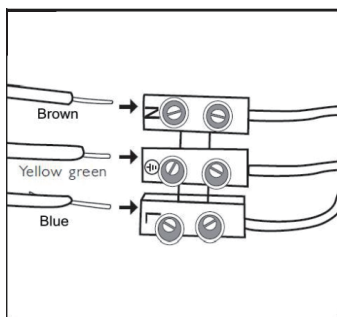

Connect the wires

5

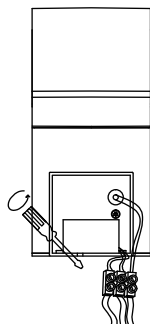

Adjust them in place

6

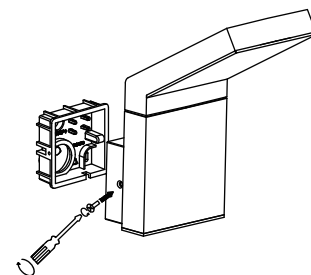

Apply side screws

7

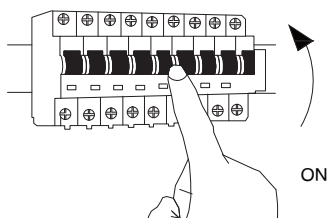

Turn on the general switch

8

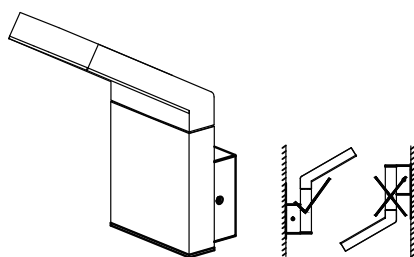

Complete the installation
by making sure to put it place properly

