

NOVA LUCE

9006054

①

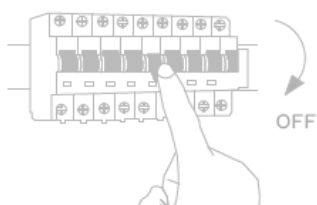

Turn off the general switch

②

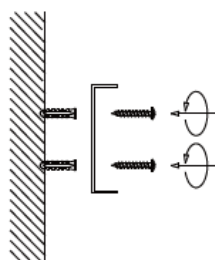

Align, mark and drill holes to apply the screws

③

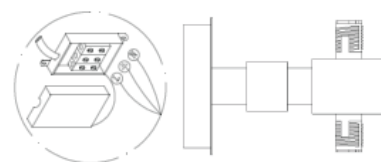

Connect the 3 wires

④

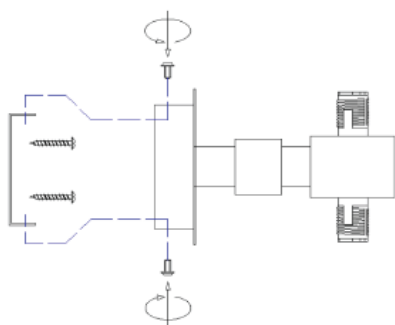

Apply the side screws

⑤

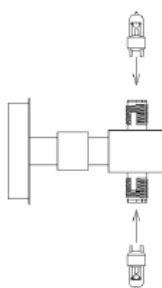

Insert the light bulb

⑥

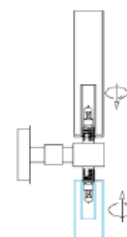

By rotating apply the glass

⑦

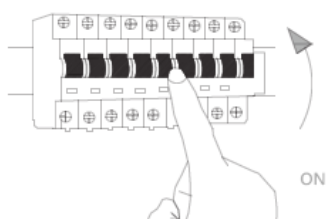

Turn on the general switch

