

NOVA LUCE

9019779

1

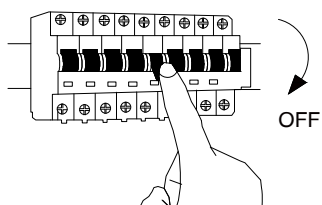

Turn off the general switch

2

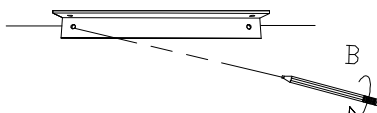

Mark & drill holes

3

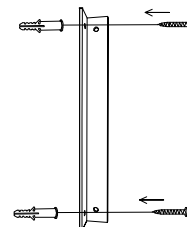

Apply plastic anchors with screws

4

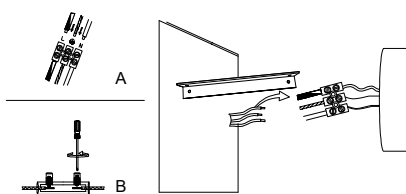

Connect wires

5

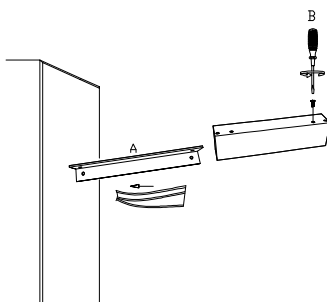

Apply the side screws

6

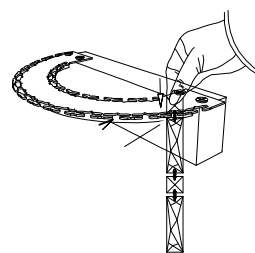

Align the crystal with the notch on the lamp body and insert it

7

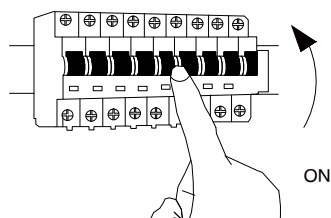

Turn on the general switch

