

NOVA LUCE

9187002

1

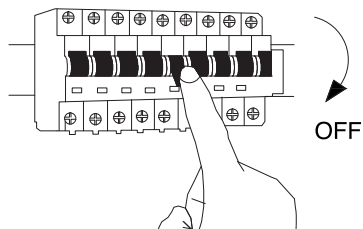

Turn off the general switch

2

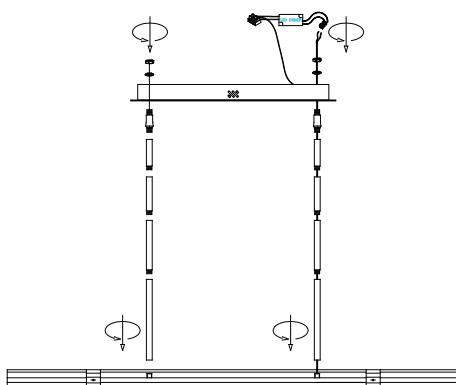

By rotating, dismantle the product

3

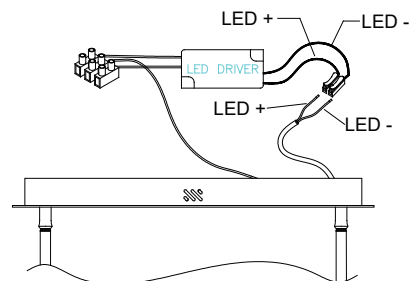

Connect the wires

4

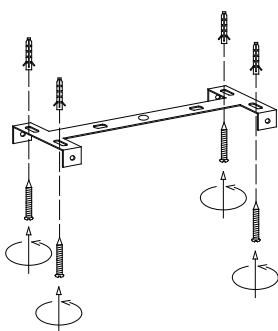

Drill holes apply plastic anchors
With screws

5

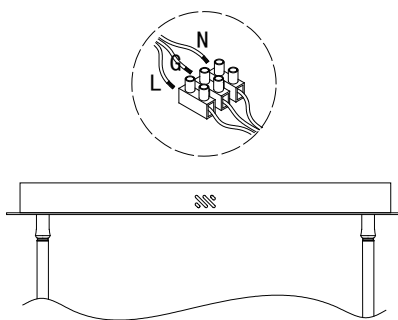

Connect the wires

6

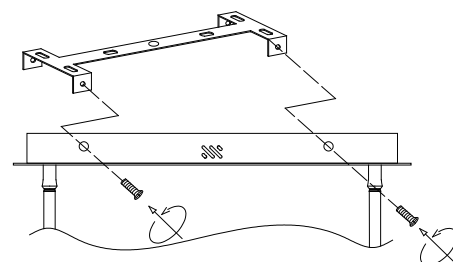

Apply side screws

7

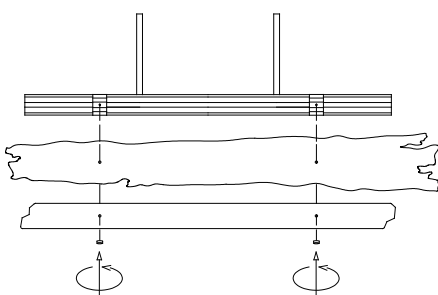

Hold the elements with the nuts

8

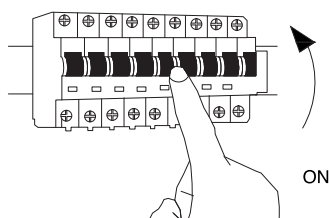

Turn on the general switch

