

NOVA LUCE

9521002

1

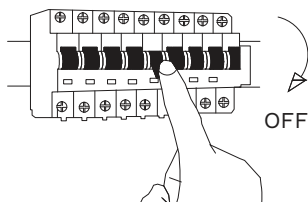

Turn off the general switch

2

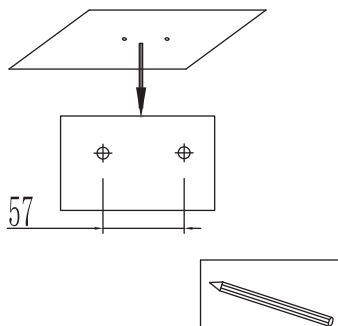

Mark the areas

3

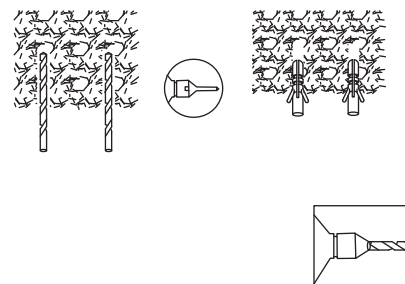

Drill holes & apply plastic anchors

4

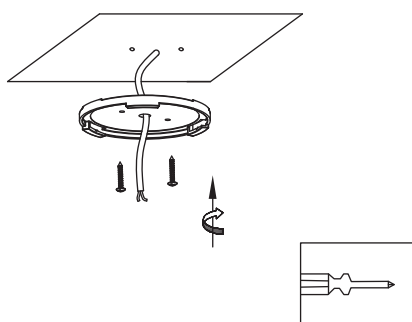

Tie up the screws to make it stable

5

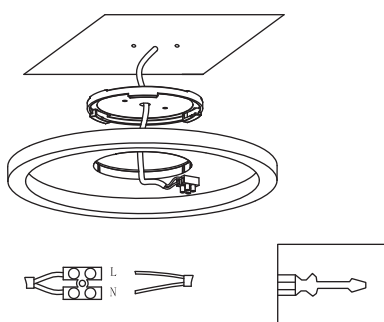

Connect the wires

6

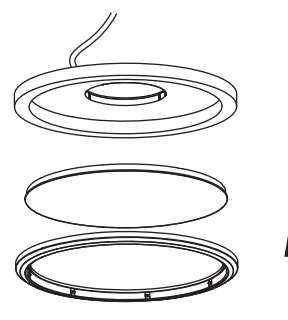

Assemble parts together

7

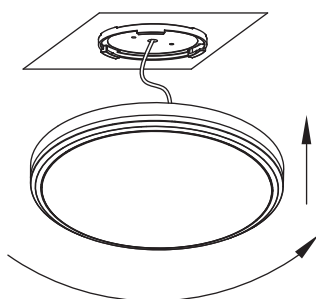

Tie up the luminaire into place

8

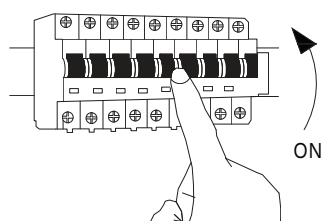

Turn on the general switch

